



## Inverter Swimming Pool Heat Pump









Model No.: Aqua R32 DC Inverter Mitsubishi-122  
Aqua R32 DC Inverter Mitsubishi-123  
Aqua R32 DC Inverter Mitsubishi-124  
Aqua R32 DC Inverter Mitsubishi-125  
Aqua R32 DC Inverter Mitsubishi-126  
Aqua R32 DC Inverter Mitsubishi-127  
Aqua R32 DC Inverter Mitsubishi-128

---

Thank you very much for purchasing our product, please keep and read this manual carefully before you install heat pump.





## Packing List

No.	Name	Qty.	Remark
1	Installation & Operation Manual	1	
2	Wire-controller	1	
3	Drain-pipe	1	
4	Drain-pipe connector	1	
5	Rubber shock absorber	4	
6	Heat Pump Unit (The pipe connector has been installed on the machine)	1	

**Please keep installation manual properly, and read it carefully before using.**

 The unit must be installed by professional personnel according to the instructions in this manual.

 **WARNING:** if the unit is installed in locations that are at risk of lightning strikes, lightning protection measures must be provided.

 **WARNING:** The unit is not suitable for use in winter: all water must be drained from the unit during overwinter or it could freeze inside the unit causing damage to the internal components.



## **Content**

1. Accessories
2. Safety
3. Heat pump working principle
4. Installation of the unit
5. Installation of the pipeline
6. Installation of optional accessories
7. Installation and operation of electric devices
8. Operating instructions
9. Wireless control
10. Adjusting and initial operation
11. Operation and maintenance
12. Fault analysis and elimination method



## 1. Accessories

Each unit produced by our factory comes with the following accessories:

No.	Name	Qty.	Use
1	Installation & Operation Manual	1 PC	User Guide to install the unit
2	Wire controller	1 PC	Used for the machine operation interface
3	Drain-pipe	1 PC	Used for draining the condensate water
4	Drain-pipe connector	1 PC	To connect the drain pipe to the heat pump
5	Shock absorb Rubber	4 PCS	To reduce vibration and noise
6	Heat pump unit	1 SET	For heating water

In order for the system to work the following parts are required

No.	Name	Qty.	use
1	Water pump	1	To circulate the pool water
2	Filter system	1	To clean the pool water which passes through the heat pumps
3	Water pipes system	1	To connect the equipment and circulate the water in the pool

### NOTE

The types and quantity of the water pipes, valves, filter equipment, sterilizing equipment used for the swimming pool heating/circulation pipe system, depend on the project design. We do not recommend to install auxiliary electric heaters in the system.

## 2. Safety

### Range of application:

1.Power supply: 220V-240V/1N~50Hz.

2.Ambient temperature: -15°C~43°C :

3.Working water temperature: Min. inlet water temperature 8°C,Max. outlet Water Temperature 40°C. If the system is always used beyond the available water range,

- The installation should be done by the professional persons, to prevent leaking, electric shock or fire.
- Confirm the ground connection, if the ground connection is not correctly done, it may cause electric shock.



THE UNIT MUST BE EARTHED PROPERLY BEFORE USAGE OR THE

When installing the heat pump in a small room, make sure it is well ventilated.

- Don't put fingers or objects into the air inlet outlet as the rotating fan could cause serious injuries.
- If you smell anything burning, turn off the manual power switch immediately, stop operation and contact the after-sale service department. Continued abnormal operation may cause electric shock fire.
- When the unit needs to be removed or re-installed, please ensure that the work is carried out by qualified professionals. If the installation is not correct, it may cause unit operation failure, electric shock, fire, hurt, leaking, etc.
- Please ensure that any repairs carried out by qualified professionals: failure to make proper repairs could cause unit operation failure, electric shock, fire, hurt, leaking, etc.
- Do no install the unit near flammable sources, as any leakages could cause a fire.
- Make sure the base on which the unit is installed is strong enough to support it.
- Make sure a leakage protection switch is installed to prevent electric shock or fire.
- When cleaning the unit, stop operation, switch off the power and disconnect the power.



## 3. Heat pump unit working principle

### 3.1 Heat pump operation

Heat pumps use heat from the sun by collecting and absorbing energy from the outside air.

This energy is then compressed and transferred to the pool water. Your existing water pump circulates the water through the heat pump, which is normally installed next to the pool filtration system, and the water warms up. The heat pump timer can be set so that the pump operates at the times you want: for example, during daylight hours from 9am to 5pm.

- The unit contains a fan that draws in outside air and directs it over the surface of the EVAPORATOR (energy collector). The liquid refrigerant inside the EVAPORATOR coil absorbs the heat from the outside air and becomes a gas.
- The warm gas inside the coil passes through the COMPRESSOR, which concentrates and increases the heat to form a very hot gas, which then passes through the CONDENSER (water heat exchanger). It is here that the heat exchange occurs as the heat from the hot gas is transferred to the cool swimming pool water circulating through the heat exchanger.
- The pool water becomes warmer and the hot gas returns to its liquid form as it flows through the CONDENSER coil. The gas then passes through the Electronic Expansion Valve and the whole process begins again.
- Developments in heat pump technology mean that today heat pumps can efficiently collect heat from the outside air even when the temperature is as low as 7-10°C. This means that for tropical and subtropical climates the pool can be maintained between 26°C and 32°C.



### 3.2 Air source heat pump working principle

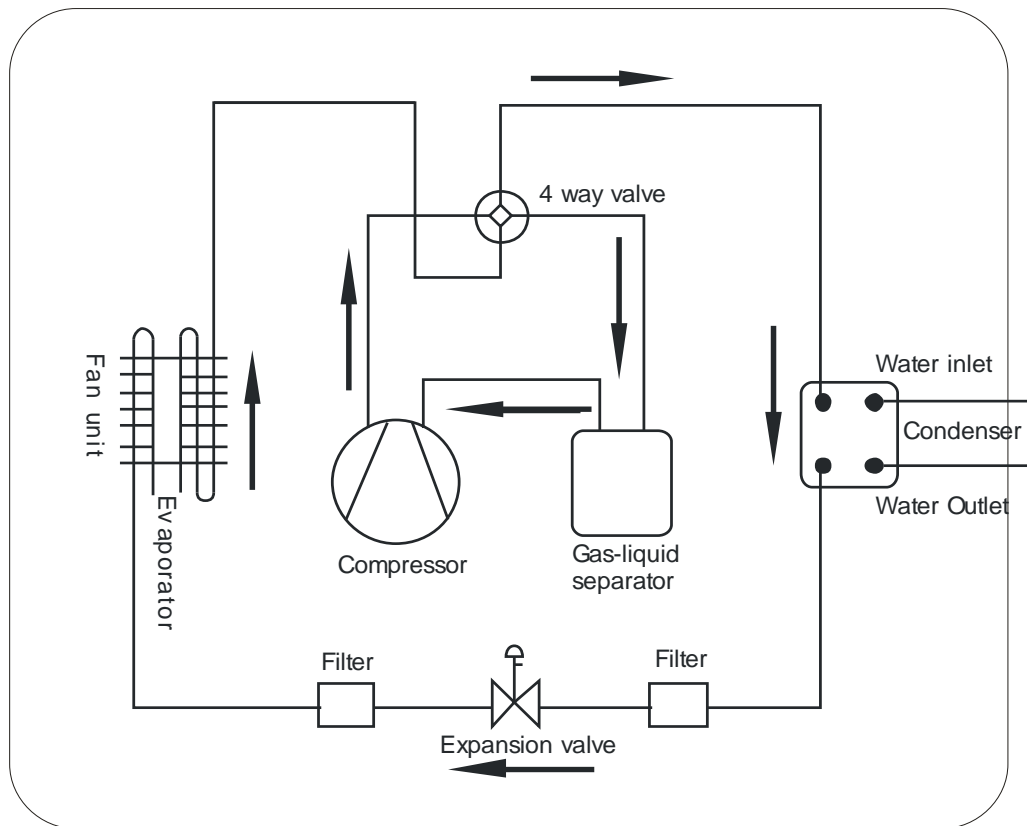

Figure 1

$Q_c$  (Heat energy) =  $Q_a$  (Compressor consumption) +  $Q_b$  (Heat energy absorbed from ambient environment)

## 4. Installation of the unit

### 4.1 Installation Guidelines

- Avoid installations in locations containing mineral oil.
- Avoid installation in locations where the air contains salt or other corrosive gases.
- Avoid installation in locations with serious power supply voltage fluctuation.
- Avoid installation in unstable places, such as a car or cabin.
- Avoid installation near flammable items.



- Avoid installation in locations with strong electromagnetic forces.
- Avoid installation in locations with harsh environmental conditions.

## 4.2 Installation check

- Check the model, number, name etc, to avoid incorrect installation.
- Make sure there is enough space for installation and maintenance.
- Install in a dry well-ventilated place and make sure there are no obstructions around the air inlet and outlet.
- Make sure the supporting base is strong enough and prepared to that shocks can be avoided.
- The power supply and diameter of the cables used must be in accordance with the electrical installation requirements.
- Electrical installation must comply with the relevant technical standards of electrical equipment, and electrical insulation work must be done.
- The unit must be put horizontally for at least eight hours before running.

### 4.2.1 Exploded view

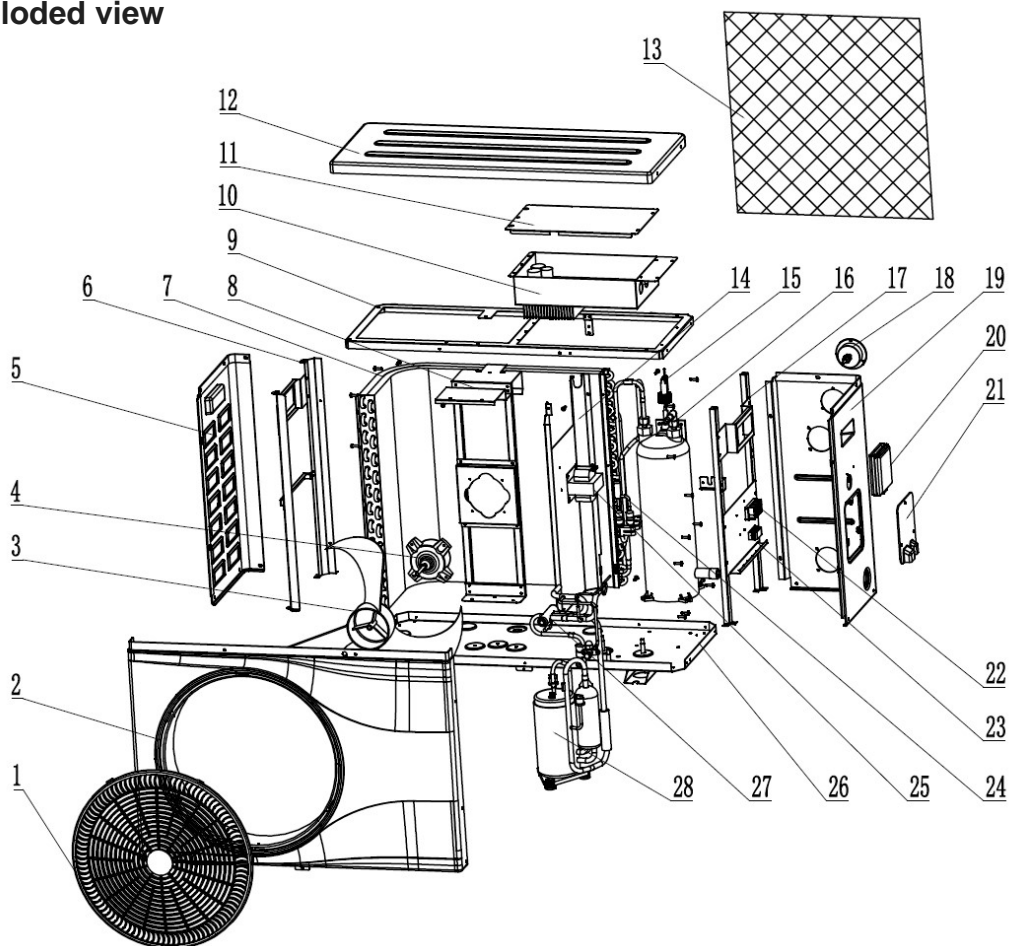



1	Fan protective gill	15	Water flow switch
2	Front panel	16	Titanium heat exchanger
3	Fan blade	17	Right panel
4	Fan motor	18	Manometer
5	Left panel	19	Right panel
6	Left structure	20	Control box
7	Evaporator	21	Electrical terminal cover
8	Fan motor mount	22	Electrical terminal block
9	Upper structure	23	Electrical cable block
10	Electric box	24	Electrical expansion valve
11	Electric cover box	25	Reactive resistance
12	Top cover	26	Bottom panel
13	Plastic net	27	Four-way valve
14	Middle panel	28	Compressor

### 4.3 Installation space

Please observe the space requirements indicated below for optimal operation and maintenance.

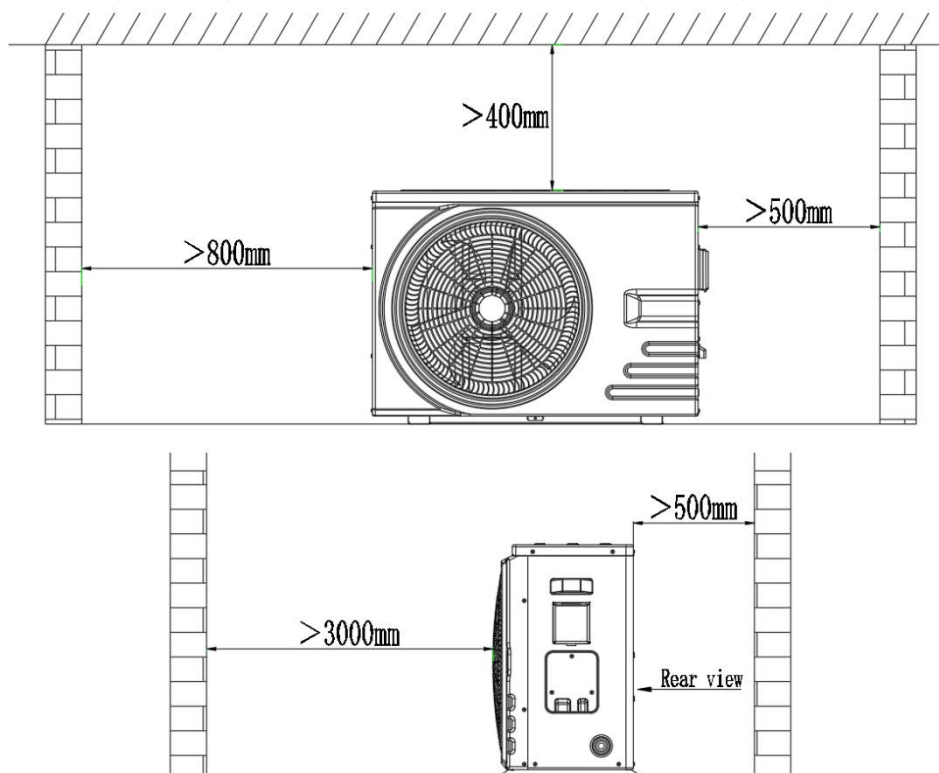

Figure 2. Horizontal installation space requirements (mm)



#### 4.4 Installation base for heat pump

Please refer to Figure 4.

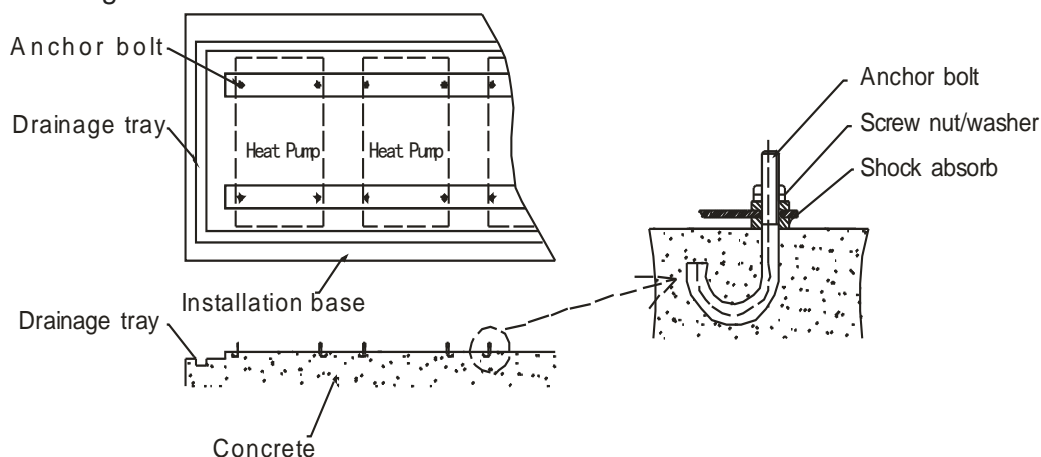

Figure 4 Installation base

#### 4.5 Lifting

- Please use four or more soft lifting belts to move the sets (see Figure 5).
- Please use protective plates on the surface of the units when handling to avoid scratches and deformation.
- Double-check that the support base is strong enough before fixing the unit.
- The heat pump will produce condensation water: remember to provide a drainage channel when making the installation base.
- Please install shock absorbers on the surface of the base.

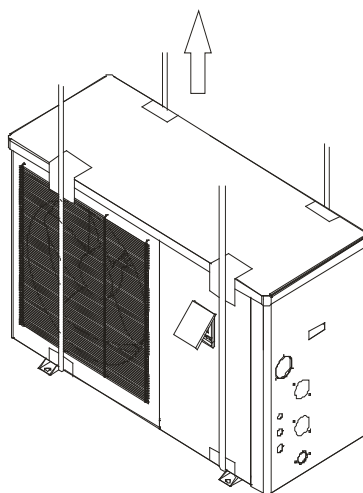

Figure 5 Lifting diagram



## 5. Installation of pipes

### 5.1 Attention

- Prevent air, dust and other material from going into the water pipes.
- Fix the whole system before installing the water pipes.
- Water inlet and outlet pipes should be protected by an insulation layer.
- Make sure that there is a stable water flow, to prevent excessive throttling.
- Do not handle, move or lift the unit by holding the water inlet and outlet pipe: use only the holes on the beam of the base (see Figure 5)
- When connecting the water inlet and outlet pipes, use two pipe wrenches to adjust the two parts of the pipes, and make sure the water inlet and outlet pipes do not twist (see Figure 6).

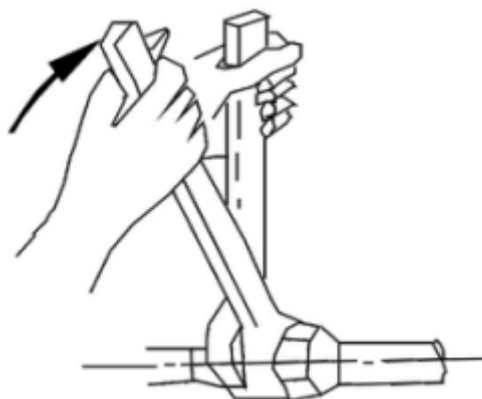

Figure 6

### 5.2 Instructions

#### 5.2.1 Symbols

Valve	Filter	Flexible connection	Check valve	Pump	Air valve	Pressure gage	Flow switch	Feeding tank	Flared joint	Hair collector	Sand Filter	Chemical dosing system



## 5.2.2 Pipeline installation diagram

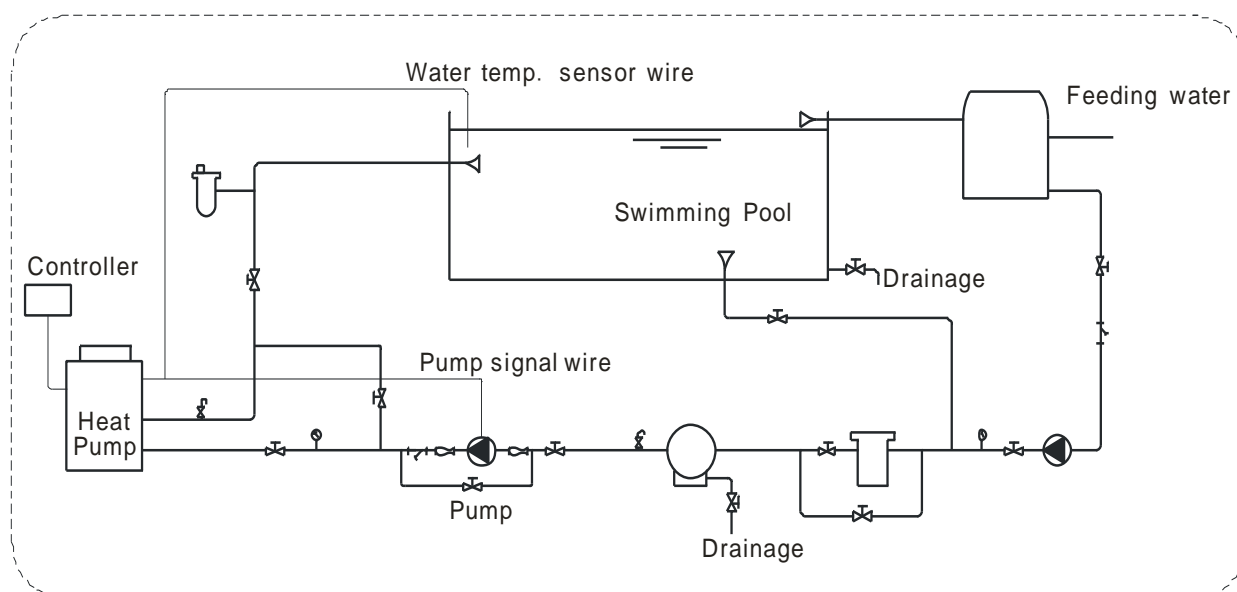

Figure 7 Diagram (Single unit for reference)

- It is recommended to install a one-way valve for each unit to prevent water back flow.
- Multiple units can be installed as part of a system, but each unit should be controlled independently.
- All pipes and valves should be insulated.

## 5.2.3 Connection sizes

Model No.	Inlet	Outlet
BYC-007/BYC-010	DN50	DN50
BYC-013/BYC-017		
BYC-021/BYC-028		

- The pipe pressure and flow rate should be calculated before selecting the diameter of the pipe, pressure drop range is 0.3~0.5 kgf/cm<sup>2</sup>(3~5m) head pipe flow rate range is 1.2~2.5 m/s.
- The hydraulic calculation should be made after selecting the pipe diameter. If the resistance is more than the pump head, then a more powerful pump or larger pipes are required.

## 5.2.4 Required Water Quality

- Bad quality water will produce more lime scale and sand: this kind of water should be filtered and demineralize.
- The water quality should be analyzed before operating the unit: PH value, conductivity, Chloride ion concentration and sulphate ion concentration should be checked.



- Acceptable water quality shown below:

PH value	Total hardness	Conductivity	Sulphate ion	Chlorine ion	Ammonia ion
7~8.5	< 50ppm	<200 $\mu$ V/cm(25 $^{\circ}$ C)	None	< 50ppm	None
<b>Sulfate ion</b>	<b>Silicon</b>	<b>Iron content</b>	<b>Sodium</b>	<b>Ca</b>	
< 50ppm	< 50ppm	< 0.3ppm	No requirement	< 50ppm	

- Suggested filter mesh = 40.

## 6. Installation of optional accessories

### 6.1 Selection of the water pump

- The circulation pump is required for the system to operate, there is a terminal connection for the pump (single phase)

**NOTE** ⚠

For single-phase pumps, please check the wiring diagram.

- Head of circulation pump = height difference between water level and main unit + total pipeline resistance (determined by the hydraulic calculation) + pressure loss of main unit (see nameplate on heat pump).

**NOTE** ⚠

Multiple units are installed in parallel place more demand on the water pump requirement.

### 6.2 Water pipe selection

- The selection of the water pipe should be based on the actual system specifications
- The flow switch can be installed horizontally or vertically. If installed the direction of the water flow must be upwards and NOT downwards.
- The flow switch must be installed on a straight pipeline, and there must be more than five times the length of the pipe diameter on either side of the flow switch (see Figure 8 below). The direction of fluid must follow the arrow on the controller. The terminal block should be installed in a position that is easy to operate.

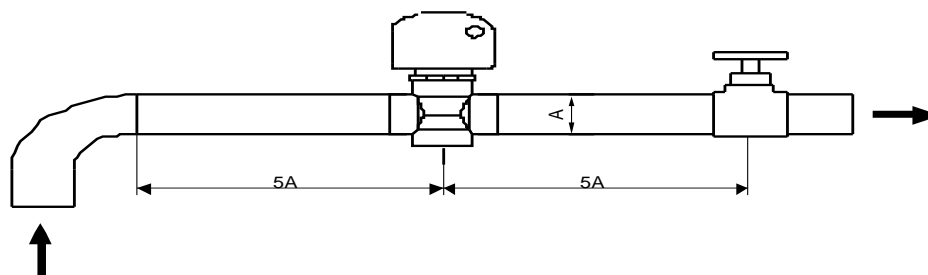

Figure 8



## 7. Installation of electrical devices

### 7.1 Electrical wiring

- The unit should have a dedicated power supply in accordance with the recommended voltage.
- Unit power supply circuit must have an effective external grounding.
- Wiring and electrical connections must be made by qualified professionals in accordance with the wiring diagram.
- Power line and signal line layout should be neat and cables should not interfere with each other.
- Do not install the units if the power supply specifications are not met.
- After all wiring connections have been completed, check them again carefully before switching on the power.

### 7.2 Electrical Wiring Specification

Model	Electrical Wiring Specification
BYC-007 BYC-010	3*1.5 mm <sup>2</sup>
BYC-013 BYC-017	3*2.5 mm <sup>2</sup>
BYC-021 BYC-028	3*4 mm <sup>2</sup>
Terminal	Terminal cable max. 4 mm <sup>2</sup>

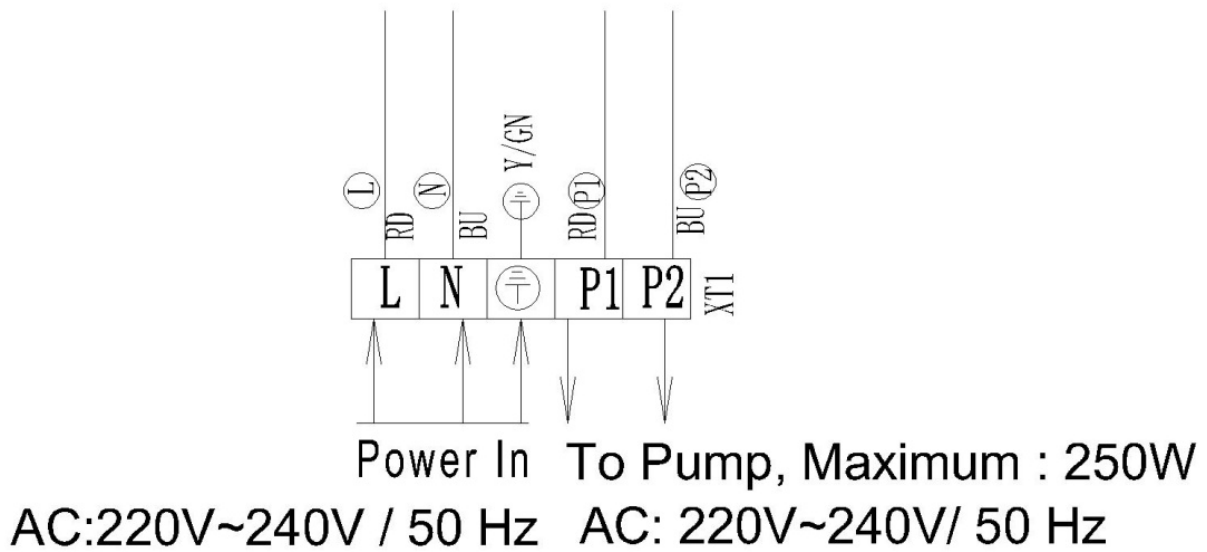

Figure 9

### 7.3 Circulation pump installation

The heat pump only provides a signal for the circulation pump, A separate A.C. Contactor is required to connect the circulation pump.

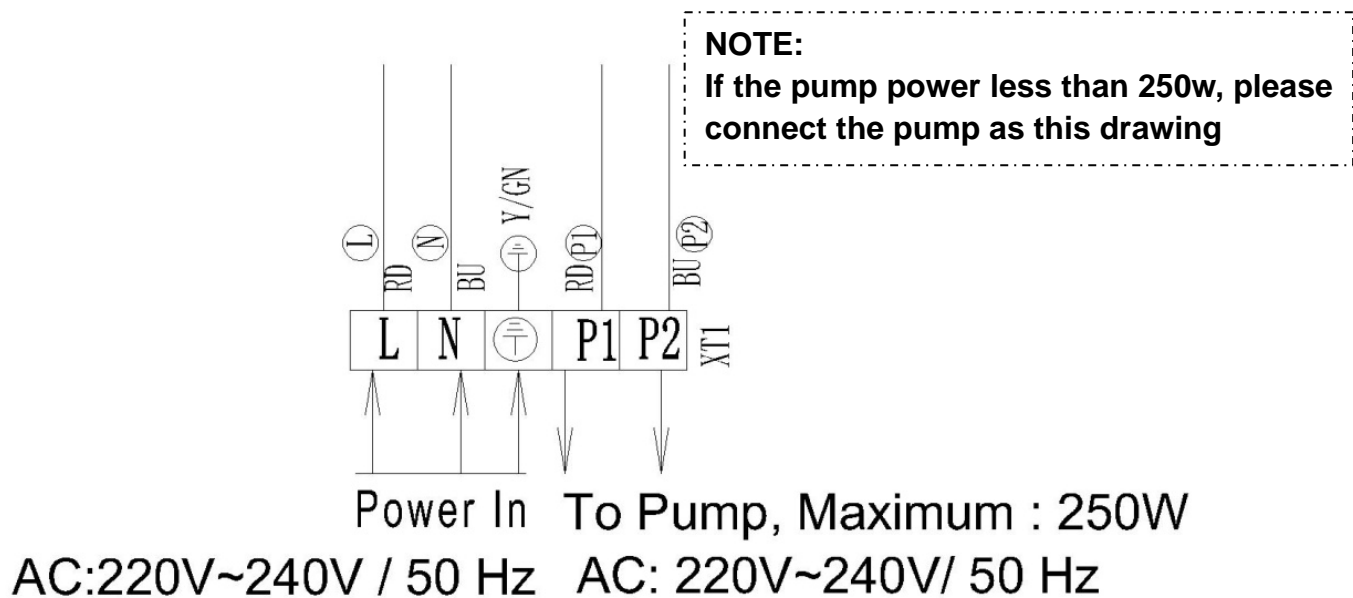

Figure 10

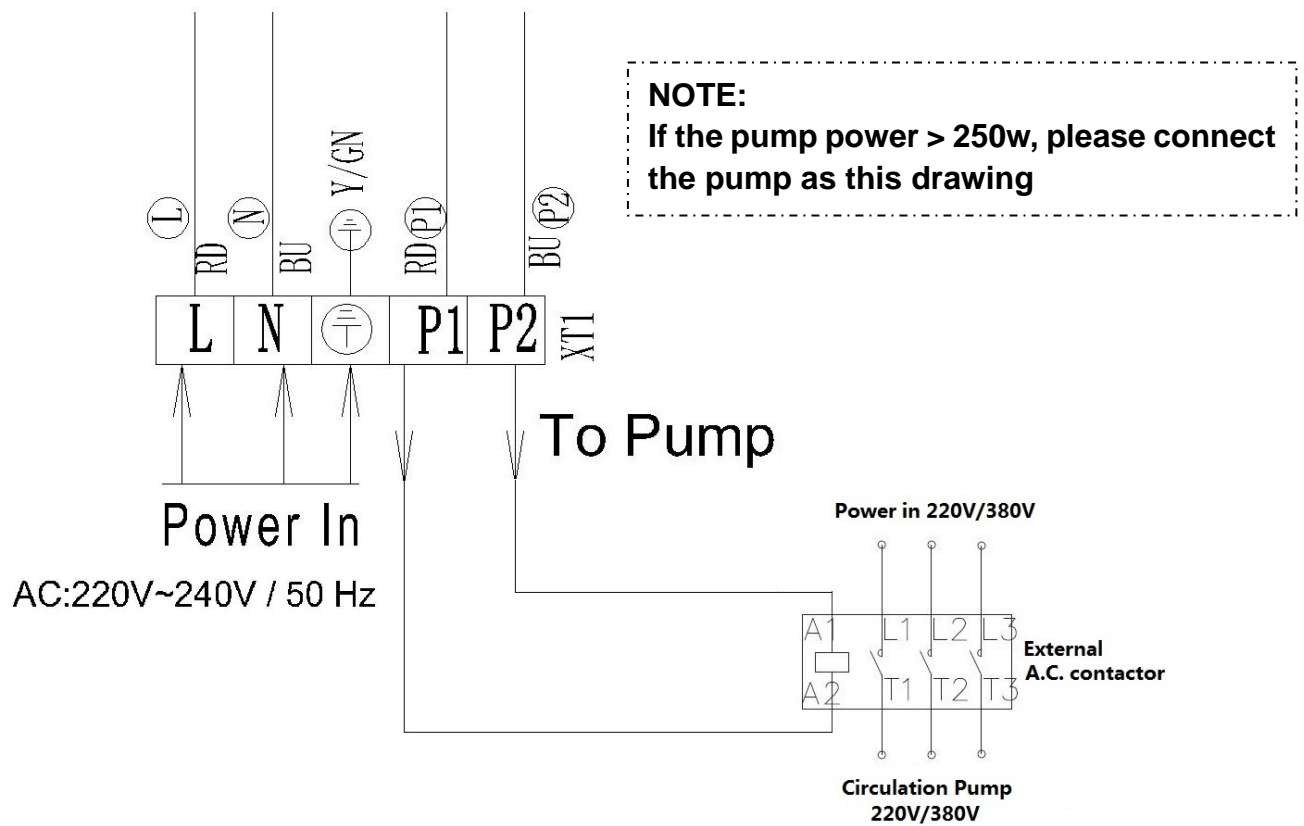

Figure 11

#### 7.4 Electric wiring diagram

COMP : COMPRESSOR	GND : GROUND
AMBT: AMBIENT TEMPERATURE SENSOR	WFS: WATER FLOW SWITCH
LOW : LOW PRESSURE SWITCH	HIGH : HIGH PRESSURE SWITCH
COIL: EVAPORATOR COIL TEMPERATURE SENSOR	OWT/INWT: INLET / OUTLET WATER TEMPERATURE SENSOR



BYC-007TC1  
BYC-010TC1

WIRE COLOR CODE	
BK	BLACK
PL	PURPLE
BU	BLUE
RD	RED
WH	WHITE
GN	GREEN
YL	YELLOW

  

Outlet Temp.	Outlet water temperature sensor
Inlet Temp.	Inlet water temperature sensor
Suc. Temp.	Suction temperature sensor
Exhaust Temp.	Exhaust temperature sensor
Amb. Temp.	Ambient temperature sensor
Coil Temp.2	Coil temperature sensor 2
Coil Temp.1	Coil temperature sensor 1
MF	Constant Current Motor Fan
4WV	4 way valve
HPS	High pressure switch
LPS	Low pressure switch
WFS	Water flow switch
COMP	Compressor
LED	LED Lamp
XT1	Terminal
EEV1	Electronic Expansion Valve
Abbreviation	Full name

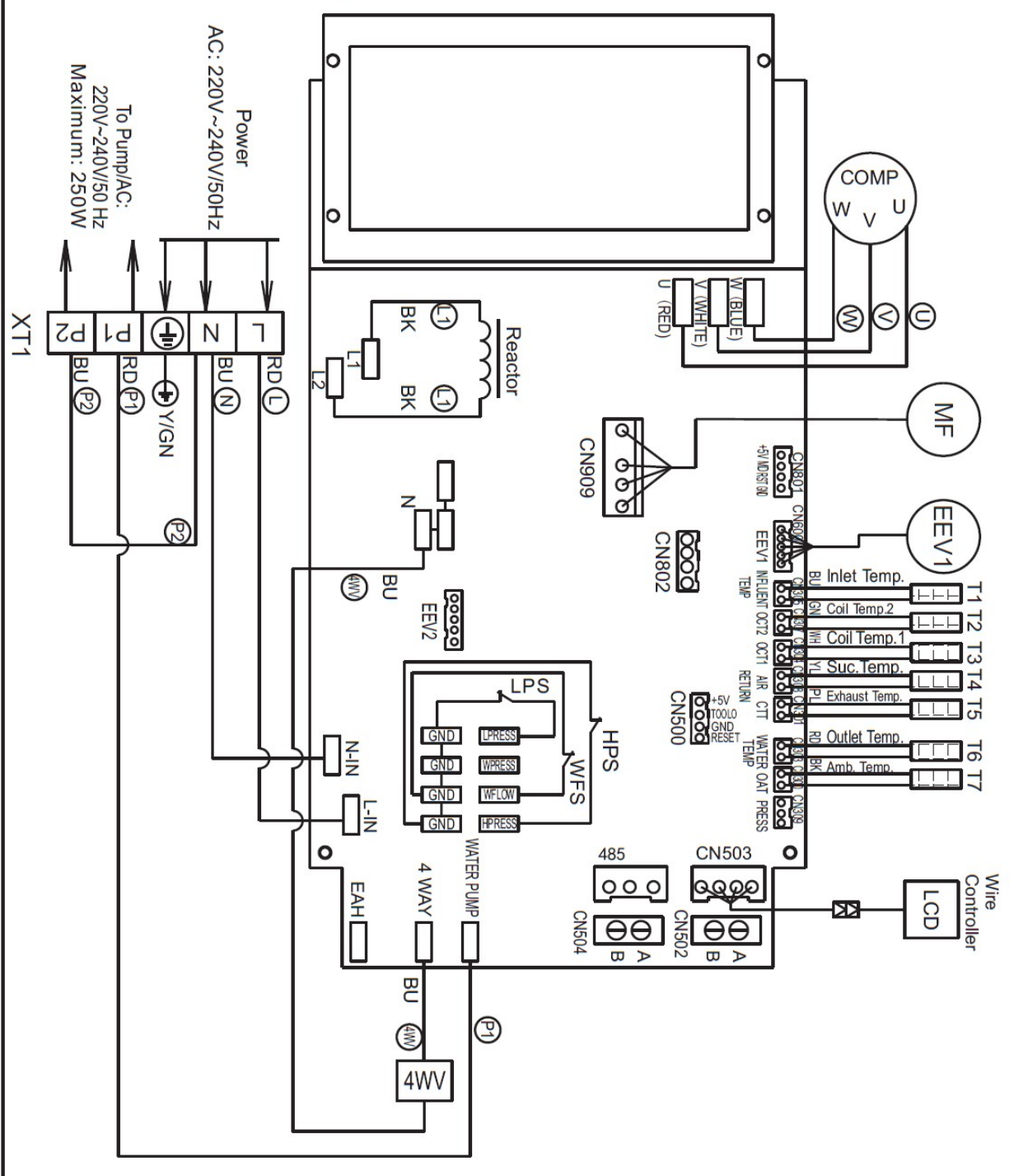



BYC-013TC1/ BYC-017TC1/ BYC-021TC1

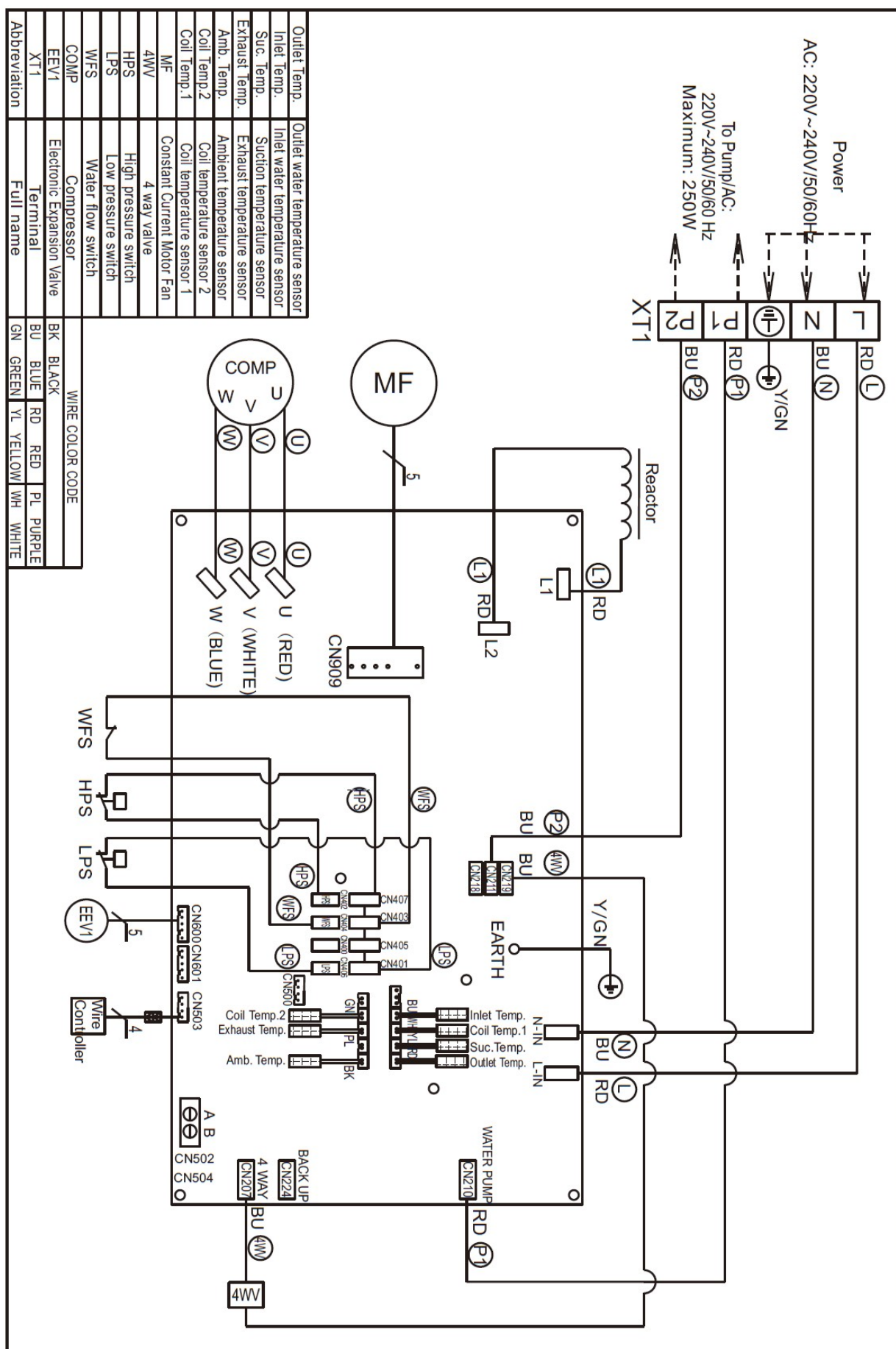





## 8. Operating Instructions

### 8.1 Wire controller (Function of buttons)



### 8.2 Definition of display

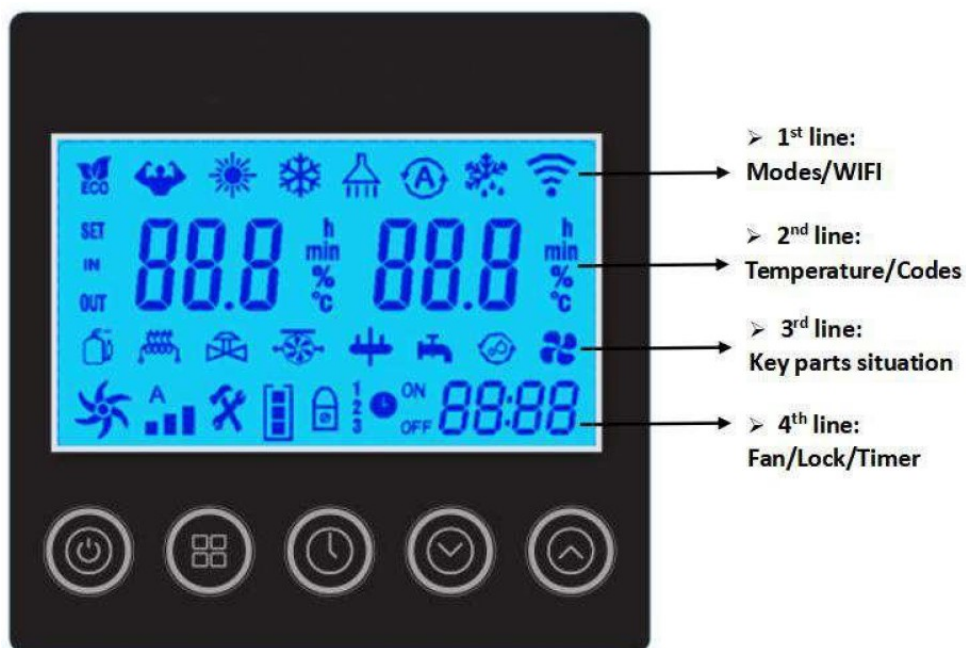







### 8.3 Start up & Locking



Step1:  Light Press this button one time to start/close the heat pump;

Step2: Press the button  to close the heat pump if in main menu, in other menus, press the button  back to the main menu.

8.3.1 Step1 (Lock): The controller will be locked when holding  for 3 seconds or the controller is standby for 60 seconds. (Purpose: to prevent children playing). Any operation is without response when it is locked. (The LCD locked If the icon  is lighted).

8.3.2 Step 2 (Unlock) : Press and hold  for 3s to change the status from lock to unlock. After this Unlock operation, the controller can response any other demands.

 Attention: Before you start, make sure the filtration pump is running and that water is flowing through the heat pump.











## 8.4 Mode Selection



Hold the button  for 3 seconds to change the below four operating modes each time.

### 8.4.1 Icon definition

- ◆  Energy Conservation Mode
  - Select Energy Conservation Mode to work with a highly economic effect in the heat pump compressor
- ◆  Heating Mode
  - Select Heating Mode to continue heat the water to the setting temperature
- ◆  Powerful Working Mode
  - Select Powerful Working Mode to run with highest capacity, trying to reach the setting water temperature in the shortest time.
- ◆   Energy Conservation Heating Mode
- ◆   Powerful Heating Mode
- ◆  Cooling Mode
  - Select Cooling Mode to cool the water to the setting temperature.
- ◆  Defrosting Mode



— — The heat pump will work with a higher economic effect if Defrosting Mode is operation by system automatically or manual.

◆  Water-Heating Mode

— — This mode only use for the heating/cooling and hot water function machine.

◆  Automatic Mode

◆  Heat Pump Compressor run

◆  Electric Heater run

◆  Water Pump run

◆  4-Way valve run

◆  Water Inlet Temperature



◆  Heat Pump FAN run

## 8.4.2 Operation steps

Step 1: Check icon  status (The LCD locked If the icon  is lighted).

Step 2: Press and hold  for 3s to change the status from lock to unlock. With this operation, the controller can response any other demands.

Step 3: Press  3 seconds to select modes, the order for different modes pops up:

 Energy Conservation Heating Mode →  Powerful Heating Mode → 

Cooling Mode (remark: mode menus are different from products, refer to chapter 6)









## 8.5 Key Parts Working Display



Key Parts

### 8.5.1 Icon definition

- ◆  Heat Pump Compressor run
- ◆  Electric Heater run
- ◆  Water Pump run
- ◆  4-Way valve run
- ◆  Water Inlet Temperature
- ◆  Heat Pump FAN run





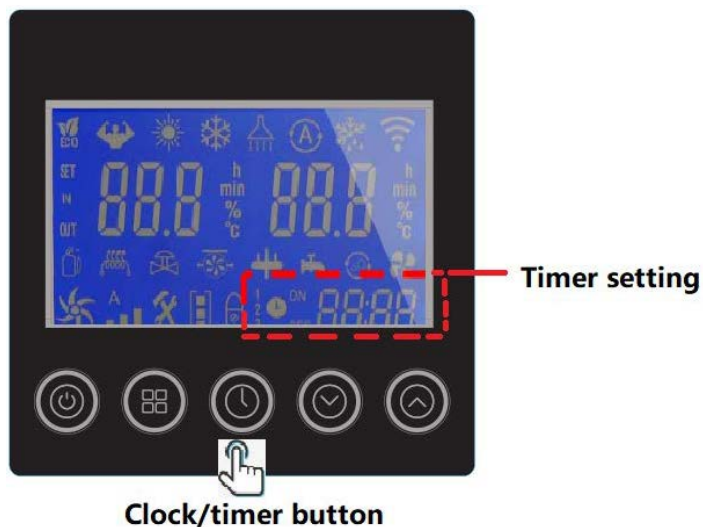

## 8.6 Timer Setting







### 8.6.1 Icon Definitions

- ◆  : Multiple phase timer setting
- ◆  Timer ON/OFF
- ◆  : Time

### 8.6.2 Time setting operation steps

Step1: Enter "hour" byte setting function after press  in main menu, "hour" byte flashed at this time

, press  or  to set the "hour".

Step2: The setting will be saved in controller after press  when "hour" setting is finished.

Step3: Enter "minute" byte setting function in mainmenu after "hour" setting is finished. "minute" byte

flashed at this time , press  or  to set the "minute".





Step4: The setting will be saved in controller after press  when "minute" setting is finished.









### 8.6.3 Timer Operation Steps

The Phase 1 timer on/off setting:

Step1: Press and hold  for 3s until   icon will be lighted, it means to enter the 1<sup>st</sup> phase timer setting function. The “hour” byte will be flashed .



Step2: Press  or  to set “hour” byte when “hour” flashed . The setting will be saved in the controller after press  when “hour” setting is finished



Step3: The “minute” byte will flashing  after “hour” setting is finished, at this time, press  or  to set the “minute” byte. The “1<sup>st</sup> phase ON timer setting will be saved in the controller after press , then the 1<sup>st</sup> phase OFF timer setting is followed automatic.

Step4: “  ” icon will be lighted after Step 3 finished, the 1<sup>st</sup> phase OFF timer setting method is same as Step1 to Step2. After the hour and minute are set, please press  to save 1<sup>st</sup> phase ON/OFF timer and return to main menu When “minute” byte is flashed.

### 8.6.4 The Phase 2、3 timer on/off setting:

The Phase 2、3 timer on/off setting:

Different operation: After finished 1<sup>st</sup> phase ON/OFF timer setting, please don't press  key to save. While please press  key to enter 2<sup>nd</sup> phase timer setting menu. Then you can see

, For the 2<sup>nd</sup> and 3<sup>rd</sup> phase ON/OFF timer setting method, please follow up “1<sup>st</sup> phase ON/OFF timer setting” steps,(refer to chapter 4.3), After finished 2<sup>st</sup> phase ON/OFF timer setting, please don't press  key to save. While please press  key to enter 3<sup>rd</sup> phase timer setting menu.





### 8.6.5 Cancel Timer Function

If the timer function already setting, Press and hold  for 3S if you need to cancel Timer once the controller is unlocked

### 8.7 Browse Function

Function 1: press  or  to browse the parameters of Heat Pump,

Function 2: In the mainmenu of Heat Pump ON, press  or  to modify the temperature for current Mode Selection. Press  to save and return to mainmenu when a modification is finished.

### 8.8. Parameters

8.8.1 Parameter status Browse: Press  to enter Parameter status Brows

Code	Description	Scope	Unit	
c01	Ambient temperature		0.1°C	
c02	Outside coil temperature		0.1°C	
c03	exhaust temperature		0.1°C	
c04	suction pipe temperature		0.1°C	
c05	reserve		0.1°C	
c06	reserve		0.1°C	
c07	Inside coil temp (after throttle)		0.1°C	
c08	water inlet temperature		0.1°C	
c09	water outlet temperature		0.1°C	
c10	reserve			
c11	reserve			
c12	reserve			
c13	sensor failure			
c14	system failure			
c15	driver failure			
c16	signal output			
c17	running status			
c18	AC voltage		V	
c19	DC voltage		V	
c20	Actual frequency		Hz	
c21	EEV open degree			
c22	reserve			
c23	heat pump current		A	
c24	compressor current		A	
c25	DC FAN Speed		Rpm	



## 8.8.2 Error Code

Code	Description
E03	flow failure
E04	anti-freeze protection
E05	high pressure protection
E06	low pressure protection
E07	Temperature sensor before auxiliary valve
E08	Temperature sensor after auxiliary valve
E09	connection failure between control mainProgram board and controller
E10	connection failure between driver and mainProgram board
E11	After throttle temp sensor failure
E12	exhaust temperature over
E15	water inlet sensor failure
E16	Outside coil sensor failure
E18	exhaust sensor failure
E20	Drive module protection
E21	ambient temperature failure
E22	vast temperature variations between inlet and outlet
E23	Water outlet temperature lower in Cooling Mode
E27	water outlet sensor failure
E29	suction pipe sensor failure
E30	Low outdoor environment temperature protection
E31	Auxiliary electric heating overload protection
E32	water outlet temperature over in Heat Mode
E33	Outside coil temperature over in Cooling Mode
E34	Compressor drive failure
E35	Compressor current over
E36	Compressor output failure
E37	IPM current failure
E38	Heat sink temperature is too high
E39	Power overload shutdown (PFC failure)
E40	DC voltage over
E41	DC voltage lower
E42	inside coil sensor failure
E43	AC voltage lower
E44	AC current over
E45	driver E2 failure
E46	DC FAN failure
E47	AC voltage over



## 8.9 Icon List

NO	Icon	Description
1		Energy Conservation Mode
2		Powerful Working Mode
3		Heating Mode
4		Heating Mode
5		Water-Heating Mode only for BCHP
6		Automatic Mode
7		Defrosting Mode
8		WIFI connection status
9		Setting
10		Water Inlet
11		Heat Pump Compressor
12		Electric Heater
13		Water Pump
14		4-Way valve
15		Heat Pump FAN
16		Wind speed steps of FAN
17		Lock
18		Multi-phase Timer
19		Timer ON/OFF
20		Time



## 9. Wireless / remote control



### WIFI Function



Step1: WIFI connection: The WIFI icon will flash to enter the WIFI connection status after power on.

It means the WIFI is successfully connected if the WIFI icon can be lighted over 5S. You can check the connection status in your mobile APP.

The WIFI icon is not lighted once WIFI connection is failed. Please reconnect following below 2 ways.→

- Method 1: Restart the controller.
- Method 2: Press and simultaneously hold three keys  +  +  for 5 seconds to reset the WIFI module, and then the WIFI icon will be flashed again).
- 

### Download and install the software:



### User registration

When using the "smart life" software for the first time, user registration is required.

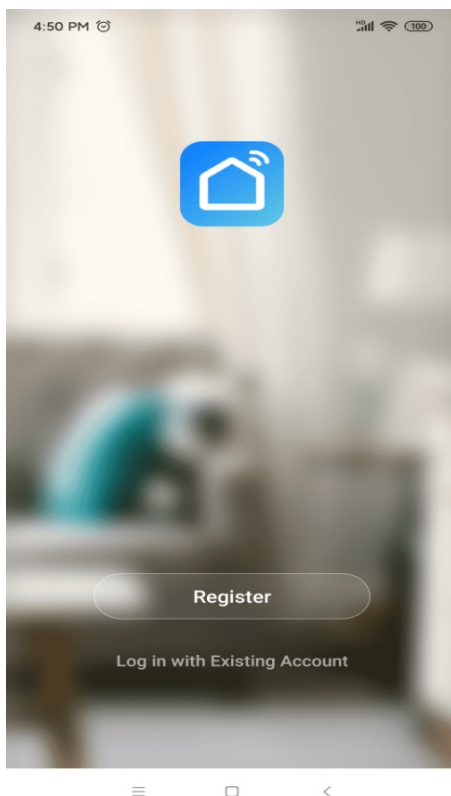

Click the "Create New User" link to enter the registration interface.

If you already have an account, just click login.

After entering the registration page, please follow the instructions on the page to register.

## User login

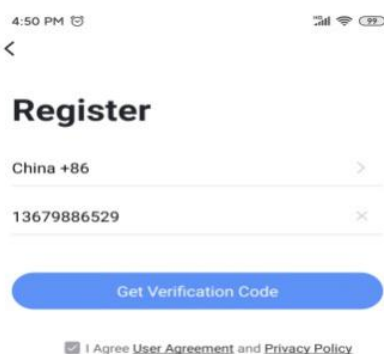

Enter the phone number you want to register and click Next

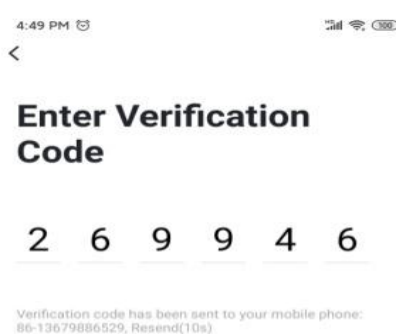

Enter confirmation code

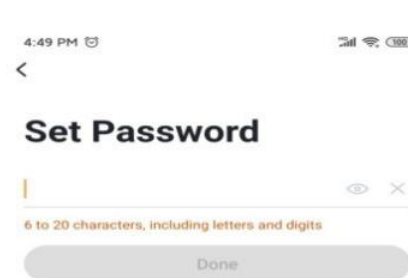

Set password

After successful registration, the software will jump to the login interface or directly log in successfully, enter the correct "user name" and "password" to log in.

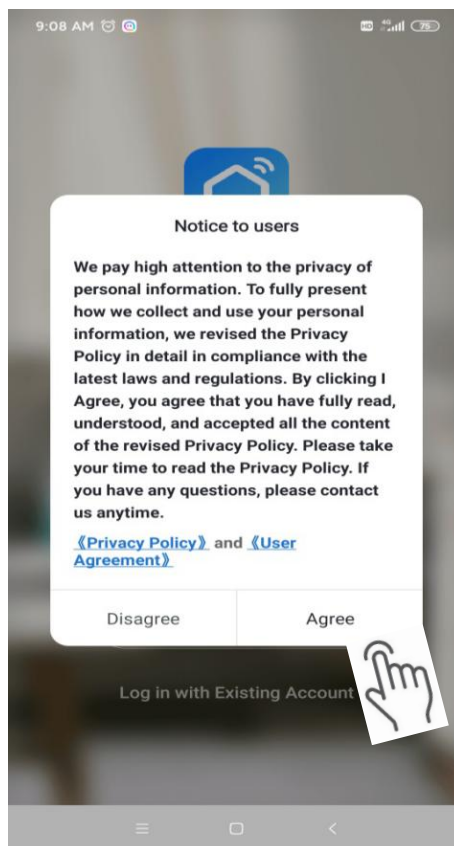
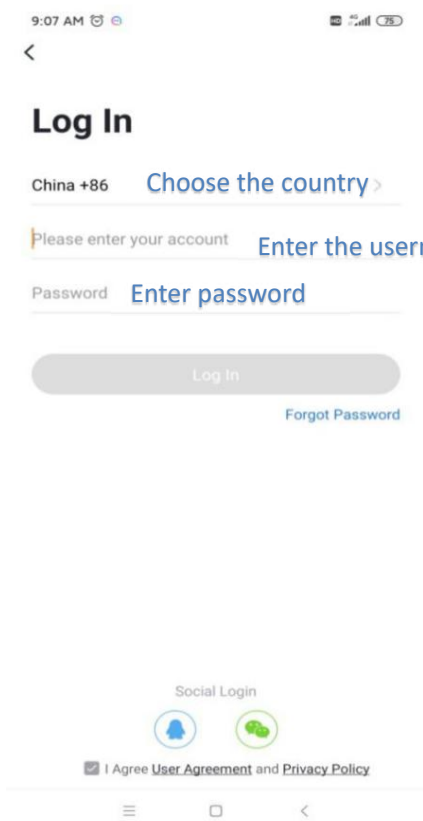

**The phone needs to be connected to the network through the WIFI network  
Connect to available Wi-Fi networks**

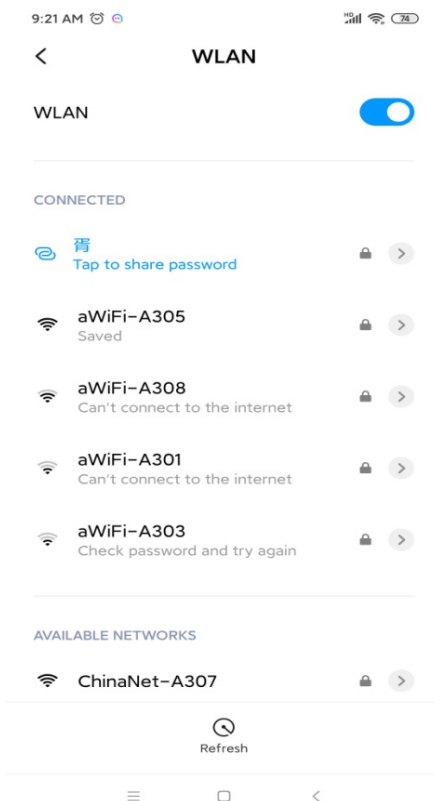

**This WIFI is not the WIFI in the module but the WIFI that can be connected to the Internet;**



After users log in to the software, they can add devices

## Device binding

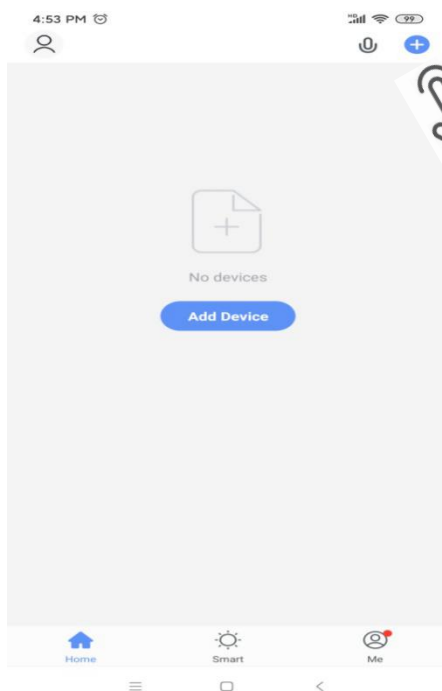

Click **+**  
or "Add Device" in the upper  
right corner to bind.

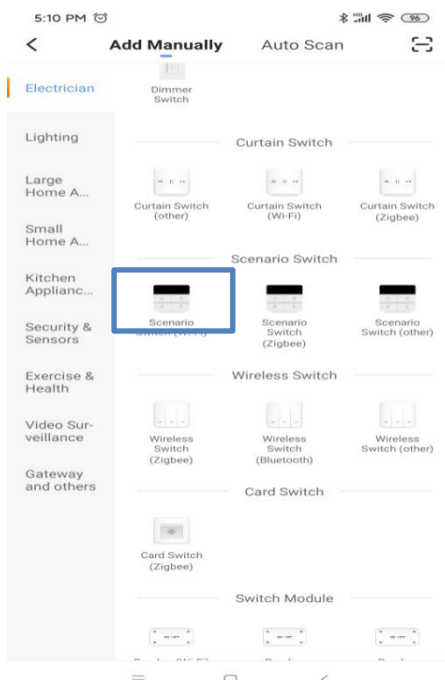

Choose "Icon Logo"

After completing the "Select Device Type", enter the "Add Device Interface", and the network configuration methods are divided into "default mode (WI-FI fast connection)" and "compatibility mode (hotspot distribution network)"



## Default mode (WI-FI fast connection):

The remote controller simultaneously press the up key + mode key for 3 seconds to enter the "default mode" distribution network

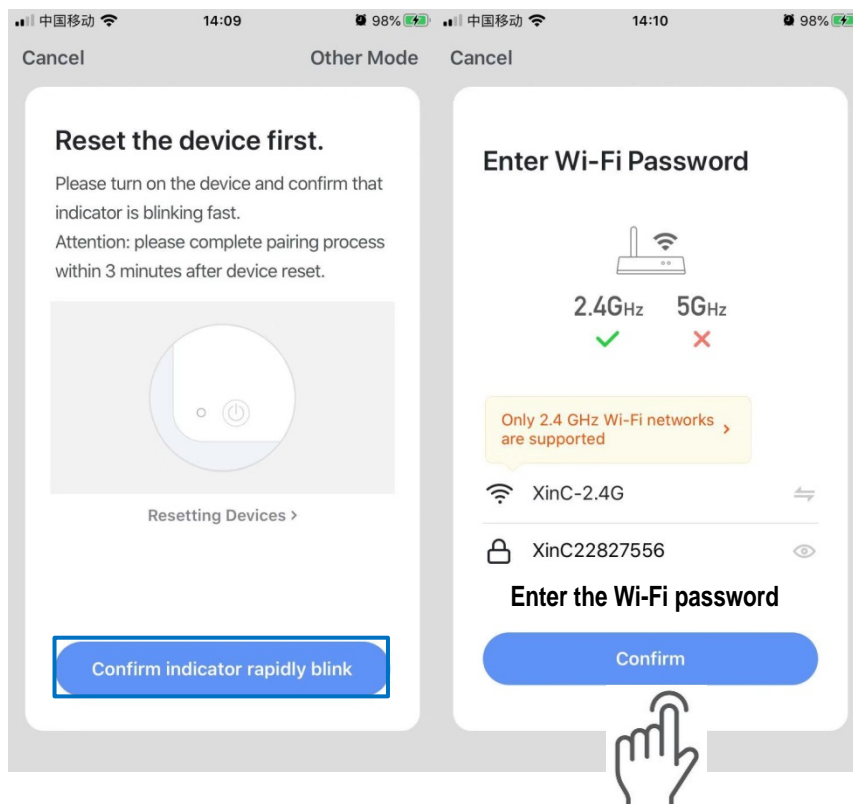

Enter the password and confirm it will jump to the connection interface

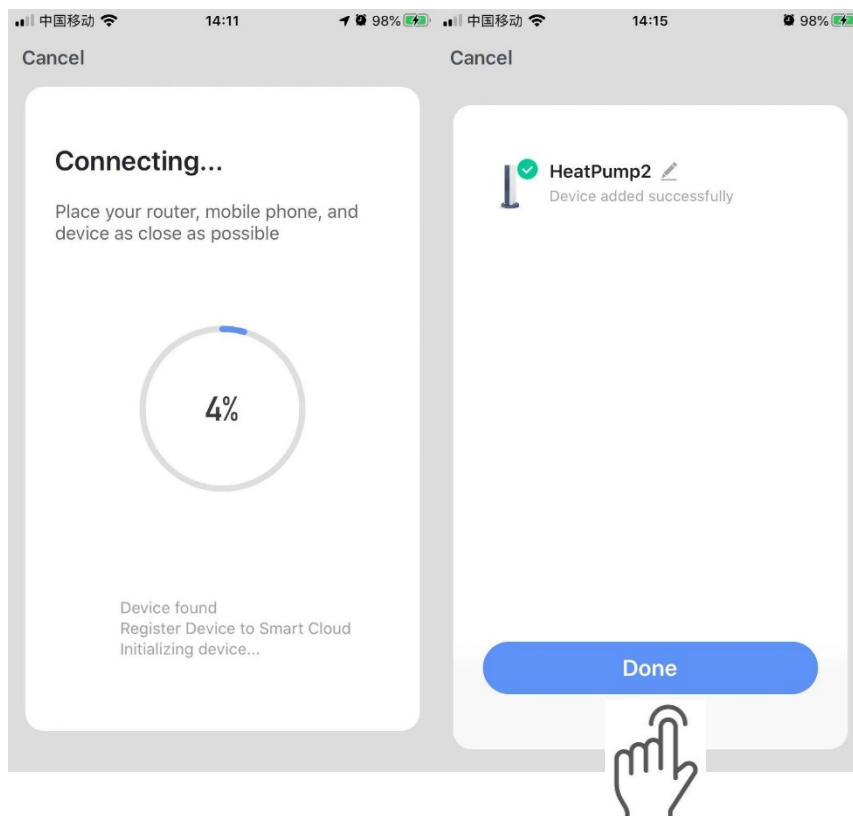



中国移动 14:17 98%  
Close

### Device not responding Try "Switch Pairing Mode"

- ① Check if the device has been reset and the indicator is blinking quickly.
- ② Check if it is 2.4 GHz Wi-Fi.
- ③ Verify the Wi-Fi password.

Retry

Switch Pairing Mode

More device-pairing FAQs

If the network distribution fails, the APP will display the page as shown in the figure, you can choose to re-add or view the help.

### Compatibility mode:

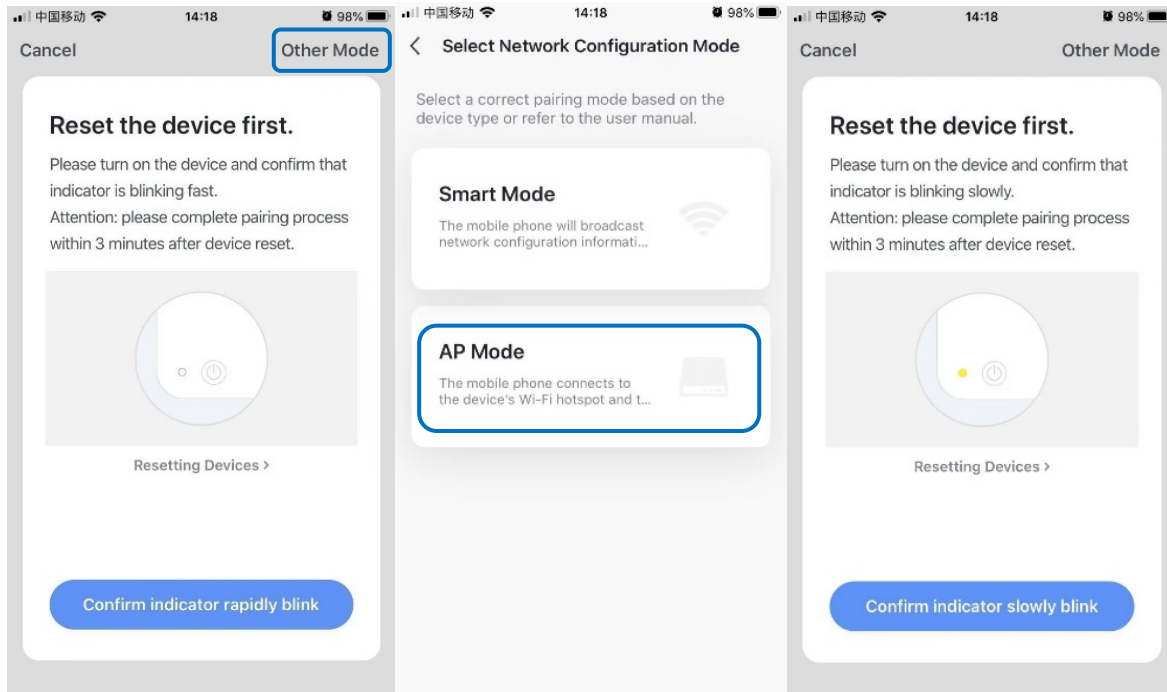

1. Select "Other Ways" in the Add Device interface
2. Select "Hot Spot Distribution Network"
3. Press and hold the timing key +, down key +, power key simultaneously for 3 seconds to enter the "compatibility mode" distribution network.

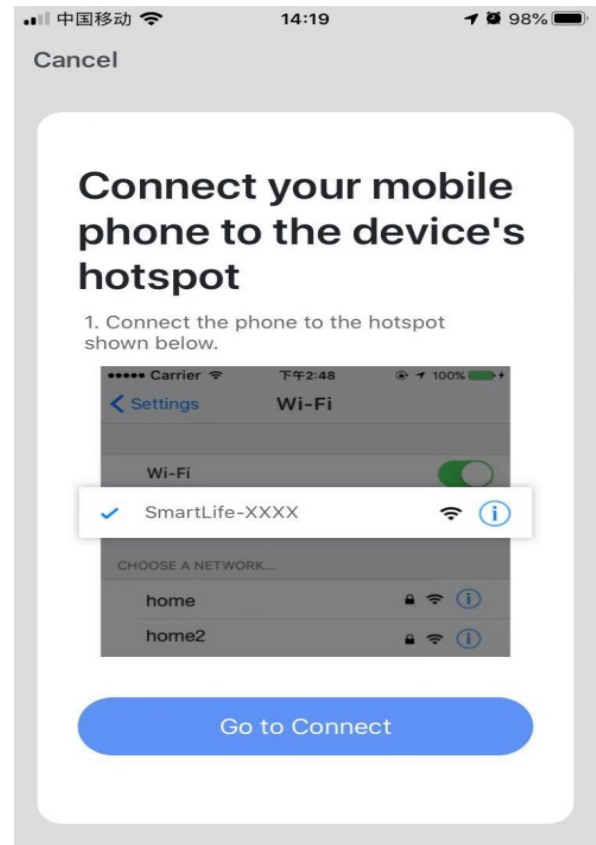
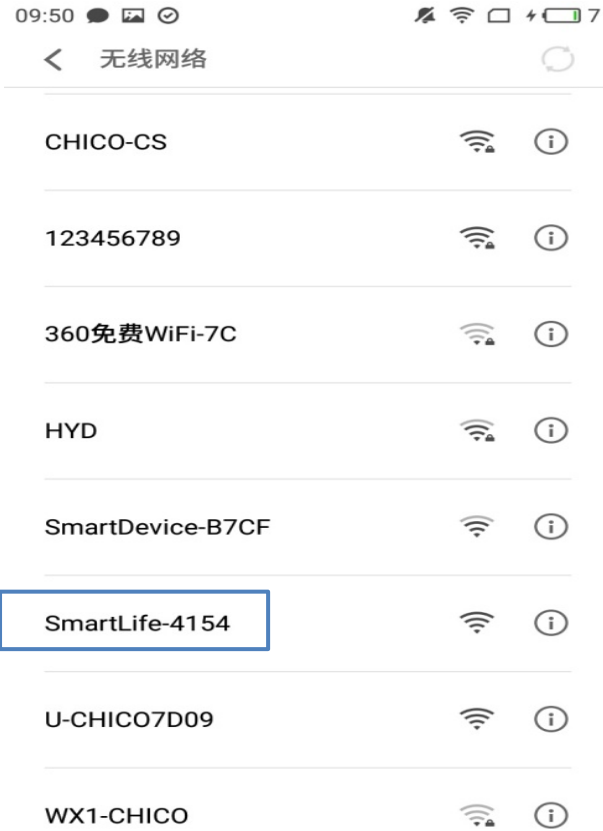

Click Go to connect and jump to the Wi-Fi interface, select Wi-Fi with the words SmartLife-xxxx

After selecting and connecting, return to the APP interface and enter the network distribution process

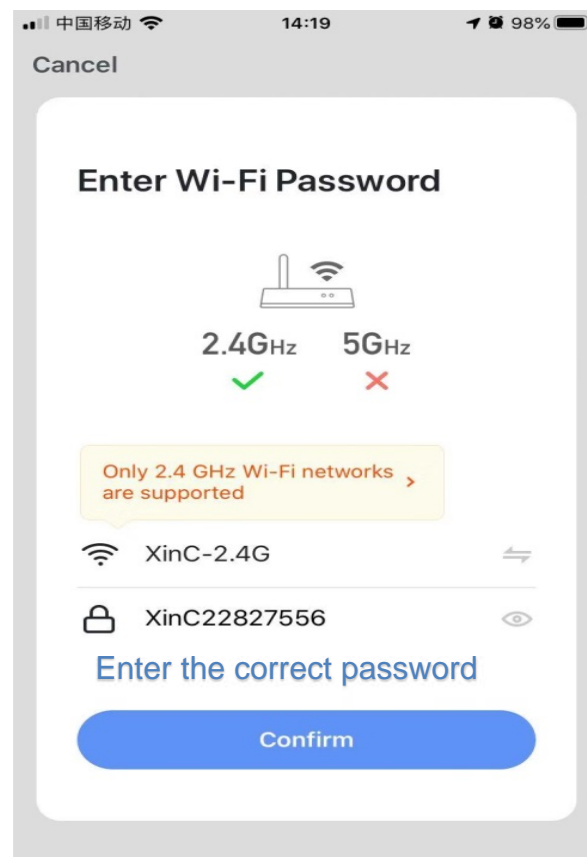



## Control introduction

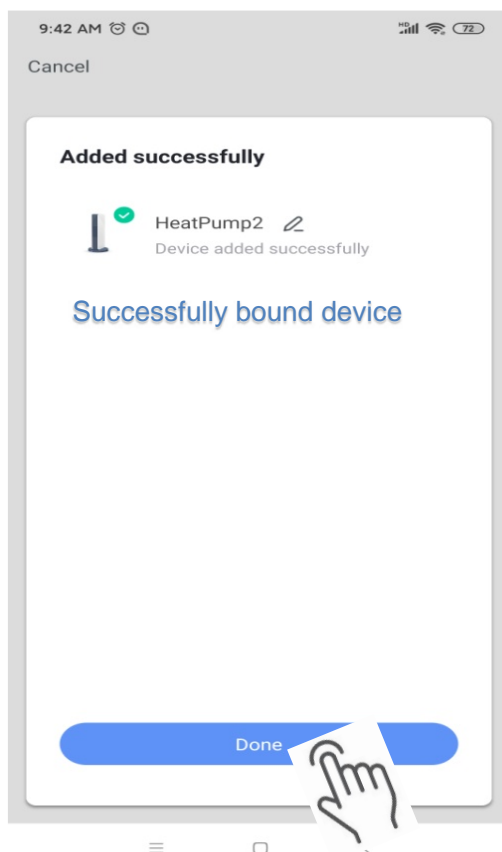



## 10.Adjusting and Initial operation

### 10.1 Attention

- Do adjustment after electrical safety inspection.
- After the power is switched on, start the test running of heat pump, to see if it can function well.
- Forced operation is forbidden, because it is very dangerous to work without protector.

### 10.2 Preparation Before Adjustment

- Check that the system is installed correctly.
- Pipes and cables are connected correctly.
- Check that accessories are installed.
- Make sure the drainage is working properly.
- Make sure the system piping and connections are properly insulated.
- Check that ground/earth connection had been made correctly.
- Check that supply voltage can meet the requirement of rated voltage.
- Check that air inlet and outlet are working correctly.
- Check that the electrical leakage protector works correctly.

### 10.3 Adjustment Process

- Check that switch of display controller works properly.
- Check that function keys on display controller work properly.
- Check that indicator lights work properly.
- Check that drainage works properly.
- Check that system works correctly after starting up.
- Check that water outlet temperature is acceptable.
- Check if there are vibrations or abnormal sounds when the system is functioning.
- Check if the wind, noise and condensate water produced by the system affect the surrounding environment.
- Check if there is any refrigerant leakage.
- If any fault occurs, please check the instructions first to analyze and remove the fault.



## 11. Operation and maintenance

**11.1 The heat pump should be installed and operated by qualified professionals. To ensure the continued correct functioning of the system it is recommended that it should be checked and maintenance should be carried out at regular. During maintenance, please pay attention to the points below:**

- Check that all parameters are normal during system operation.
- Check for loose electrical connections and fix if necessary.
- Check electrical components and replace if necessary.
- After prolonged use, there may be calcium or other mineral substances deposited on the surface of the heat exchanger copper coil. This could affect the performance of heat exchanger and lead to higher than normal electrical consumption, increased discharge pressure and reduced suction pressure. Formic acid, citric acid, acetic acid or other organic acid can be used to clean the coil.
- Any dirt accumulated on the surface of the evaporator fins should be blown away using a 0.6Mpa air compressor, brushed by fine copper wire, or flushed with a high-pressurized water hose, usually one time per month. If there is too much dirt, we can use a paintbrush dipped in gasoline to clean the evaporator.
- After restarting the unit following a long period of inactivity, please do the following: examine and clean the equipment carefully, clean the water pipe system, check the water pump and fasten all the wire connections.
- Always use original replacement parts.

### 11.2 Refrigerant

Check the refrigerant filling condition by reading the data of the liquid level from the display screen, and also by checking the air suction and exhaust pressure. If there is a leakage or any components of the refrigeration circulation system have been changed, it is necessary to check the air tightness before anything else.

### 11.3 Leak detection and air tightness testing

During leak detection and air tightness experiment, never allow oxygen, ethane or other harmful flammable gases to enter the system: only compressed air, fluoride or refrigerant can be used for such a test.

### 11.4 To remove the compressor, please do the following

- Turn off the power supply
- Remove the refrigerant from the low pressure end; make sure you reduce the exhaust speed, and avoid leakage of frozen oil.



- Remove the compressor air suction and exhaust pipe.
- Remove the compressor power cables.
- Remove the compressor fixing screws.
- Remove the compressor.

**11.5 Conduct regular maintenance according to the user manual instruction, to make sure the unit running is in good condition.**

- If there is a fire, disconnect the power immediately and put the fire out with fire extinguisher.
- The unit's operating environment should be free of gasoline, ethyl alcohol and other flammable materials to avoid explosions or fire.
- Malfunction: if any malfunction occurs, find the reason, fix it and then reboot the unit. Never reboot the unit forcibly if the cause of the malfunction has not been eliminated. If there is refrigerant leakage or frozen liquid leakage, switch the unit off. If it is not possible to turn the unit off from the controller then disconnect the main power supply..
- Never short connect the wire for device protection otherwise, in case unit malfunction, the unit will not be protected normally and could be damaged.



## 12. Fault analysis and elimination method

Fault	Possible cause	Detection and elimination method
Discharge pressure is too high.	<ul style="list-style-type: none"> <li>◆ There is air or other non-condensable gas existed in the system.</li> <li>◆ Water heat exchanger is scaling or fouling blockage.</li> <li>◆ The circulation water volume is not enough.</li> <li>◆ Refrigerant charging is too much.</li> </ul>	<ul style="list-style-type: none"> <li>● Vent the air from water heat exchanger</li> <li>● Wash and clean the water heat exchanger</li> <li>● Examine the water system pipeline and pump.</li> <li>● Drain part of the refrigerant</li> </ul>
Discharge pressure is too low.	<ul style="list-style-type: none"> <li>◆ Liquid refrigerant flow through evaporator to compressor, which make foam for the frozen oil</li> <li>◆ Suction pressure is too low</li> <li>◆ Refrigerant charging is too less, the refrigerant air goes into liquid pipeline</li> </ul>	<ul style="list-style-type: none"> <li>● Examine and adjust the expansion valve, make sure the expansion valve temperature sensor bulb is close connected with the air suction pipe, and absolutely insulated with the ambient environment.</li> <li>● Please refer to "Fluorine filling if suction pressure too low"</li> </ul>
Suction pressure is too high.	<ul style="list-style-type: none"> <li>◆ Discharge pressure is too high.</li> <li>◆ Refrigerant charging is too much.</li> <li>◆ Liquid refrigerant flow through evaporator to compressor.</li> </ul>	<ul style="list-style-type: none"> <li>● Drain part of the refrigerant.</li> <li>● Examine and adjust the expansion valve, make sure the expansion valve temperature sensor bulb is close connected with the air suction pipe, and absolutely insulated with the ambient environment.</li> </ul>
Suction pressure is too low.	<ul style="list-style-type: none"> <li>◆ Ambient temperature is too low.</li> <li>◆ The evaporator liquid inlet or compressor suction pipe is blocked, expansion valve unadjusted, or failed.</li> <li>◆ The refrigerant is not enough in the system.</li> </ul>	<ul style="list-style-type: none"> <li>● Adjust suitable overheat temperature, examine whether there is Fluorine leakage from the expansion valve temperature sensor bulb.</li> <li>● Examine Fluorine leakage.</li> <li>● Examine the installation condition.</li> </ul>
Compressor stopped because of high pressure protection.	<ul style="list-style-type: none"> <li>◆ The water inlet temperature is too high, circulation water is not enough.</li> <li>◆ The high pressure stop setting is not correct, the air suction overheat greatly.</li> <li>◆ Fluorine filling is too much.</li> </ul>	<ul style="list-style-type: none"> <li>● Examine water system pipeline and water pump.</li> <li>● Examine the high pressure switch.</li> <li>● Examine the Fluorine filling volume, drain part of refrigerant.</li> </ul>
Compressor stopped because of motor overloading.	<ul style="list-style-type: none"> <li>◆ The voltage is too high or too low.</li> <li>◆ Discharge pressure is too high or too low.</li> <li>◆ Device loading failure.</li> <li>◆ Ambient temperature is too high.</li> <li>◆ Motor or connecting terminal is in short circuit.</li> </ul>	<ul style="list-style-type: none"> <li>● The voltage should be controlled within more or less 20V than rated voltage, and phase difference within <math>\pm 30\%</math>.</li> <li>● Examine the compressor current, compare with the full loading current indicated in the user manual.</li> <li>● Improve air ventilation.</li> </ul>
Compressor stopped because of built-in thermostat.	<ul style="list-style-type: none"> <li>◆ The voltage is too high or too low.</li> <li>◆ Discharge pressure is too high.</li> <li>◆ The refrigerant in the system is not enough.</li> </ul>	<ul style="list-style-type: none"> <li>● Examine the voltage to make sure it is within the specialized range.</li> <li>● Examine the discharge pressure and find out the reason.</li> <li>● Examine whether there is Fluorine leakage.</li> </ul>
Compressor stopped because of low voltage production	<ul style="list-style-type: none"> <li>◆ Dry filter clogging.</li> <li>◆ Expansion valve failure.</li> <li>◆ The refrigerant is not enough.</li> </ul>	<ul style="list-style-type: none"> <li>● Examine, maintain, or change dry filter.</li> <li>● Adjust or change expansion valve.</li> <li>● Fill in refrigerant.</li> </ul>
High noise of compressor	<ul style="list-style-type: none"> <li>◆ There is liquid hammer for liquid refrigerant flowing through evaporator to compressor.</li> </ul>	<ul style="list-style-type: none"> <li>● Adjust liquid supply, examine whether normal for the expansion valve and air suction over heat degree.</li> </ul>
Compressor can not start.	<ul style="list-style-type: none"> <li>◆ Over current relay is tripped, insurance is burn.</li> <li>◆ The control circuit is not connected.</li> <li>◆ No current.</li> <li>◆ The pressure is too low, which can not conduct the pressure switch.</li> <li>◆ The contactor coil is burn out.</li> <li>◆ Water system failure, relay is tripped.</li> </ul>	<ul style="list-style-type: none"> <li>● Set the control circuit in manul mode, restart the compressor after maintenance.</li> <li>● Examine controlling system.</li> <li>● Examine power supply.</li> <li>● Examine whether the refrigerant is too less.</li> <li>● Reconnect, adjust two of the wiring.</li> </ul>



## **14. After-sale service**

**If your heat pump does not operate normally, please turn off the unit and cut off the power supply at once, then contact our service center or technical department.**